

Schlüter®-BEKOTEC

Flooring structure

curl resistant, crack free, thin layer screed system

9.1

Product data sheet

Application and Function

Schlüter®-BEKOTEC is a modular screed system for crack free and functionally safe floating screeds and heated screeds with coverings made of ceramic tiles, natural stone or other suitable materials.

The system is based on the studded polystyrene screed panel, Schlüter®-BEKOTEC-EN, which is directly installed on top of load bearing substrates or conventional heat insulation and/or sound insulation panels. The geometry of the Schlüter®-BEKOTEC-EN studded panel results in a minimum screed thickness of 32 mm between the studs and 8 mm above the studs. The studs form a grid pattern with a distance of 75 mm between them to accept the 16 mm diameter heating pipes if a heated screed is to be installed. The floor heating system is easily adjustable and ideally suited for use with low temperatures, since the screed volume to be heated or cooled is relatively small (approx. 57 kg/m² or 28.5 l/m² with 8 mm coverage).

The curing stresses that occur in the screed due to shrinkage are absorbed by the studded pattern, thus controlling deformations such as curling over the entire area. It is therefore unnecessary to install movement joints or control joints in the screed. As soon as the cement screed is ready to support weight, the uncoupling mat Schlüter®-DITRA 25 (alternatively: Schlüter®-DITRA-DRAIN 4 or Schlüter®-DITRA-HEAT) can be installed (calcium sulfate screed ≤ 2 CM-%). Ceramic tiles or natural stone tiles are then installed directly over this layer, using the thin-bed method. Movement joints in the covering layer are created using Schlüter®-DILEX according to industry guidelines.



Cover materials that are not susceptible to cracking, such as parquet or carpeting, can be directly installed over the screed as soon as it reaches the necessary residual moisture level for the corresponding covering.

Material

Schlüter®-BEKOTEC-EN 2520 P is made of polystyrene EPS 033 DEO (PS 20) and is especially suitable for use with conventional cement screeds of strength class CT-C25-F4 (ZE 20) or calcium sulfate screed CA-C25-F4 (AE 20).

Schlüter®-BEKOTEC-EN 1520 PF is made of polystyrene EPS 033 DEO (PS 25) and has a foil cover on the topside. It is especially well suited for flowing screeds.

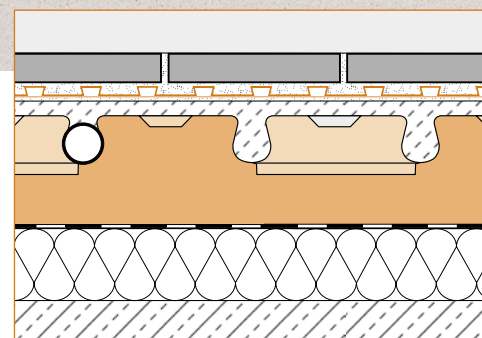



Installation

1. Schlüter®-BEKOTEC-EN is installed over an even and sufficiently load bearing substrate. Larger uneven sections should be levelled with screed or suitable fill materials prior to installation. If required, install additional suitable insulation materials on the substrate, observing the applicable regulations for sound and/or heat insulation. If cables or pipes are installed on the load bearing substrate, install a full layer of sound insulation in accordance with DIN 18560-2 above the levelling layer. Observe the maximum compressibility CP4 (≤ 4 mm) when selecting a suitable insulation material. If the construction height does not allow for using polystyrene or mineral fibre insulation, the Schlüter®-BEKOTEC-BTS sound insulation membrane with a thickness of just 5 mm can achieve a significant improvement in sound insulation.
2. The 8 mm thick perimeter strip, Schlüter®-BEKOTEC-BRS 810, is placed at the perimeter, where the covering meets wall or fixtures. The foil leg integrated into the edge strip must be positioned between the substrate (or the top insulation layer) and the studded panel. If a flowing screed is to be applied, the Schlüter®-BEKOTEC-BRS 808KF with adhesive leg is used. The edging strip is attached to the wall using the adhesive strip on the reverse side. Placing the screed panel onto the self adhesive foam leg prevents back flow of the screed.
3. The Schlüter®-BEKOTEC-EN modular screed panels must be cut to size in the peripheral areas. Use of the special edge board, Schlüter®-BEKOTEC-ENR 1520P (see page 4), simplifies cutting and minimises waste. The Schlüter®-BEKOTEC panels are equipped with a mortise and tenon type edge design for interconnection.
4. To create a Schlüter®-BEKOTEC-THERM comfort floor, the system pipes with a diameter of 16 mm are now clamped between the cut back studs. The spacing of the pipes must be determined on the basis of the required heating output, as shown in the Schlüter®-BEKOTEC heating diagrams.

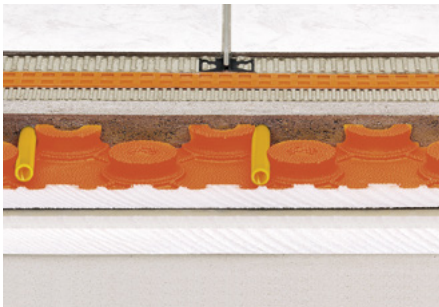

5. As part of the screed installation, cement screed with strength class CT-C25-F4 (ZE 20) or calcium sulfate screed CA-C25-F4 (AE 20) is installed with a minimum screed cover of 8 mm over the studded panels. The flexural strength of the screed may not exceed F5. The screed thickness may be increased to a maximum of 25 mm above the studs for levelling. To avoid sound transmission between individual rooms, the screed should be separated at the threshold using the expansion joint profile Schlüter®-DILEX-DFP.
6. As soon as the cement screed is ready to support weight, the uncoupling mat Schlüter®-DITRA 25 (alternatively: Schlüter®-DITRA-DRAIN 4 or Schlüter®-DITRA-HEAT) can be adhered, observing the installation instructions of product data sheet 6.1 (alternatively: 6.2 or 6.4). Gypsum based screeds may be covered as soon as they have reached a residual moisture content of < 2 CM %.
7. Ceramic tile or natural stone can be directly installed on top of the uncoupling mat, using the thin bed method. The ceramic covering must be divided into fields with movement joints above the uncoupling mat in accordance with the applicable regulations. We recommend the movement joint profiles Schlüter®-DILEX-BWB / -BWS / -KS / -AKWS for creating movement joints (see also product data sheets 4.6, 4.7, 4.8 and 4.18).
8. Our corner movement profiles Schlüter®-DILEX-EK or Schlüter®-DILEX-RF (see product data sheet 4.14) can be used as a flexible edge joint in floor to wall transition areas. The protruding sections of the Schlüter®-BEKOTEC-BRS edging strip should first be trimmed.
9. The Schlüter®-BEKOTEC-THERM ceramic thermal comfort floor is ready for heating just seven days after the completion of the cover assembly. Increase the supply temperature by a maximum of 5 °C a day to reach the desired operating temperature, starting from 25 °C water temperature.



10. Covering materials that are not susceptible to cracking (e.g., parquet, carpeting or synthetic coverings) are directly installed over the BEKOTEC screed without the uncoupling mat. The height of the screed must be adjusted to the corresponding material thickness. In addition to the applicable installation guidelines, note the permissible residual moisture level of the screed for the selected covering material.

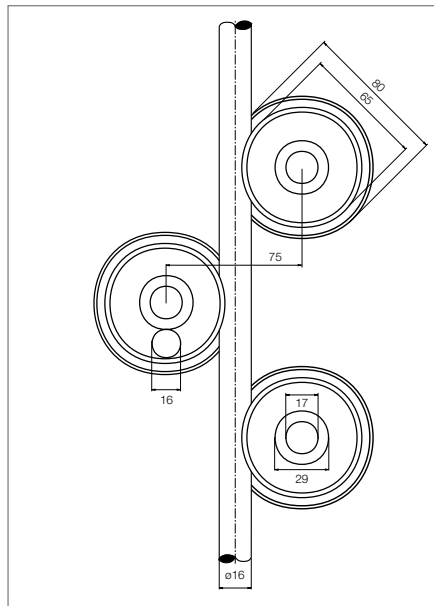
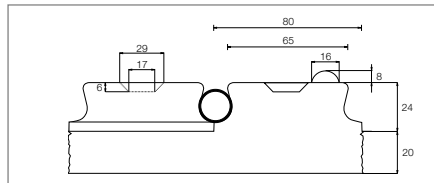

Maintenance

Schlüter®-BEKOTEC-EN / -ENR / -BRS / -BTS will not rot and require no special care or maintenance. Before and during the application of the screed, the studded screed panel may need to be protected from mechanical damage with suitable measures, such as laying out timber boards.

Technical Data

1. Stud diameter: 65 mm
Grid spacing for heating pipes: 75 mm
Diameter of system heating pipes: 16 mm
The studs have a cutback design to securely keep heating pipes in place without the need for clamps.
2. Connections: The studded panels have a tongue and groove design for snap in connection. The short sides of the studded Schlüter®-BEKOTEC panels can also be abutted at the long sides to cut down on material waste.
3. Panel size (working area):
 $75.5 \times 106 \text{ cm} = 0.80 \text{ m}^2$.
Panel height: 44 mm
4. Packaging: 20 pieces per box = 16 m^2
Box size is approximately $120 \times 80 \times 60 \text{ cm}$. The corners of the box are reinforced with edge protectors.

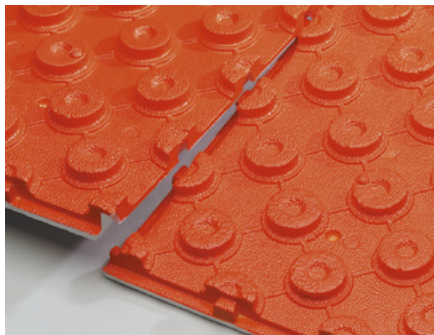
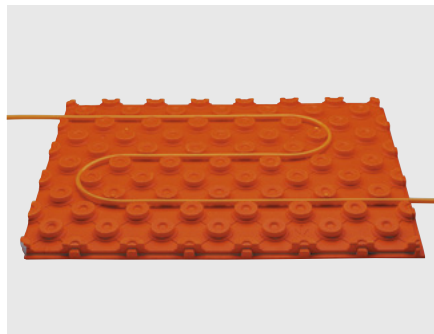



Supplementary System Products

Edge board

The edge board, Schlüter®-BEKOTEC-ENR 1520P, is used at edge and recessed areas to simplify cutting and minimise waste. It consists of EPS 040 DEO material and features a mortise and tenon type edge design for interconnection. The boards can be placed along their longer sides.

Packaging: 20 pieces per box

Dimensions: 30.5 x 45.5 cm

Thickness: 20 mm



Edging strip for conventional screeds

Schlüter®-BEKOTEC-BRS 810 is an edging strip made of closed cell polyethylene foam with an integrated foil leg. The edge strip is positioned at floor to wall transitions or fixed building elements, with the foil leg placed onto the substrate below the Schlüter®-BEKOTEC panel between the substrate (or the top insulation layer) and the studded panel.

Roll: 50 m length x 10 cm width x 8 mm thickness

Schlüter®-BEKOTEC-BRSK 810 is identical to the above edging strip, but features an adhesive strip on the reverse side for attachment to walls.

Roll: 50 m, width: 10 cm, thickness: 8 mm



Edging strip for flowing screeds

Schlüter®-BEKOTEC-BRS 808KF is an edging strip with an adhesive leg of PE foam and an adhesive strip on the back for attaching to walls.

Placing the Schlüter®-BEKOTEC studded panel onto the PE adhesive leg creates a connection that prevents flowing screeds from running beneath the board.

Roll: 25 m, width: 8 cm, thickness: 8 mm



Impact sound insulation

Schlüter®-BEKOTEC-BTS is a 5 mm thick impact sound insulation membrane, made of closed cell polyethylene foam to be installed below Schlüter®-BEKOTEC-EN. The use of Schlüter®-BEKOTEC-BTS leads to significant improvement in impact sound insulation. The material can be used if the room height is not sufficient for the use of sound insulation material made of polystyrene or mineral fibre in the corresponding thickness.

Roll: 50 m, width: 1.0 m, thickness: 5 mm



Expansion joint profile

Schlüter®-DILEX-DFP is an expansion joint profile for installation in door transition areas to prevent sound bridges. Thanks to the bilateral coating and the self adhesive strip, straight line installation is very easy.

Length: 1.00 m, height: 60 / 80 / 100 mm, thickness: 10 mm

Length: 2.50 m, height: 100 mm, thickness: 10 mm

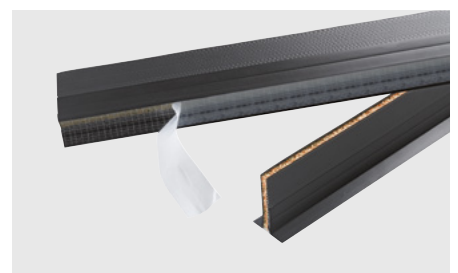



Benefits of the Schlüter®-BEKOTEC System

- **Warranty:**

Schlüter-Systems offers a five year warranty for the life of the cover assembly, provided all installation instructions were observed and the covering is used as intended.
- **Crack free covering:**

The Schlüter®-BEKOTEC system is designed to reduce shearing tensions in the screed within the grid of the studded panel. No construction reinforcement is required.
- **Non buckling construction:**

The cover assembly of the Schlüter®-BEKOTEC system is free of inherent stresses. Consequently, buckling in the system is virtually impossible. This is especially applicable in the presence of temperature fluctuations; e.g. with heated screeds.
- **Joint free screed:**

The regular patterns of the Schlüter®-BEKOTEC studded panel evenly reduce tensions in the screed, which allows for constructing the screed without movement joints.
- **Movement joints in the joint pattern of the tile or stone covering:**

With the Schlüter®-BEKOTEC system, the design of movement joints can match the joint pattern of the tile or stone covering, since it is not necessary to continue construction joints from the screed into the surface covering. The applicable regulations for the placement and construction of movement joints in and around the tile field must be observed.
- **Short construction time:**

As soon as the screed produced with the Schlüter®-BEKOTEC system is able to support weight, coverings of ceramic tile, natural stone or artificial stone can be directly installed on top of the membrane. Ceramic thermal comfort floors are ready for heating only seven days after the completion of the cover assembly.
- **Low construction height:**

Compared to conventional heated screeds according to DIN 18 560-2, the Schlüter®-BEKOTEC system saves 37 mm in construction height.
- **Material savings:**

Only 57 kg/m² ± 28.5 l/m² of screed are required with a screed cover of 8 mm. This advantage is reflected in the static calculation.
- **Fast reacting heated floor assembly:**

Compared to conventional heated screeds, cover assemblies installed with a Schlüter®-BEKOTEC-THERM ceramic thermal comfort floor react much faster to temperature changes, since the volume to be heated or cooled is much lower. Consequently, the heated floor system is particularly suitable for operation at low temperatures.

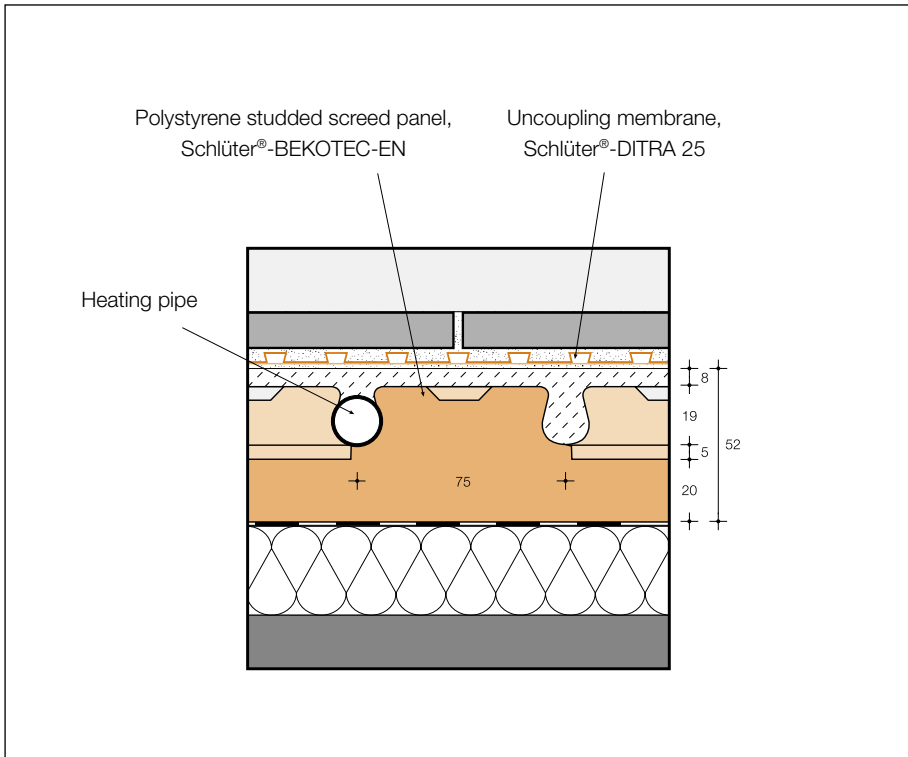

Coordination regarding impact sound insulation, thermal insulation etc. is required during planning!

Product Overview

Schlüter®-BEKOTEC-EN

Studded Screed Panel	Measurements	Packaging
EN 2520P (without foil cover)	75.5 cm x 106 cm = 0.8 m ² working area	20 pieces (16 m ²) per box
EN 1520PF (with foil cover)	75.5 cm x 106 cm = 0.8 m ² working area	20 pieces (16 m ²) per box
ENR 1520P (edge board)	30.5 cm x 45.5 cm	20 pieces per box

Schlüter®-BEKOTEC-BRS

Edging strip	Measurements	Roll	Packaging
BRS 810 (for conventional screeds)	8 mm x 100 mm	50 m	10 rolls
BRSK 810 (for conventional screeds)	8 mm x 100 mm	50 m	10 rolls
BRS 808KF (for flowing screeds)	8 mm x 80 mm	25 m	10 rolls

Schlüter®-BEKOTEC-BTS

Impact sound insulation	Measurements	Roll	Packaging
BTS 510	5 mm x 1 m	50 m	1 roll

Schlüter®-DILEX-DFP

DFP = Expansion joint profile Length: 1.00 m

H = mm	Packaging
60	20 pieces
80	20 pieces
100	20 pieces

Schlüter®-DILEX-DFP

DFP = Expansion joint profile Length: 2.50 m

H = mm	Packaging
100	40 pieces



Text template for tenders:

_____ m²

- Impact sound and heat insulation
- Heat insulation

for installation below Schlüter®-BEKOTEC-EN, to be supplied and professionally installed on a sufficiently level substrate while observing the manufacturer's instructions.

- Mineral fibre, type _____
- Polystyrene, type _____
- Extruded rigid foam, type _____
- Foam glass, type: _____

If using flowing screed, the complete layer of insulation panels may need to be covered with a PE separating foil. The installation instructions of the manufacturer must be observed.

Material: _____/m²

Labour: _____/m²

Total price: _____/m²

_____ m² Schlüter®-BEKOTEC-BTS 510 as an impact sound insulation membrane made of a 5 mm thick, closed cell polyethylene foam for installation below Schlüter®-BEKOTEC-EN on a sufficiently level substrate, to be supplied and professionally installed. The installation instructions of the manufacturer must be observed.

Material: _____/m²

Labour: _____/m²

Total price: _____/m²

For conventional mortar screeds:

_____ m² Schlüter®-BEKOTEC-EN 2520P Studded screed panel made of polystyrene EPS 033 DEO (PS 30) with a working area of 106 x 75.5 cm and a tongue and groove connection mechanism, with 70 studs of 24 mm height, of which 4 studs feature a 8 mm high hemispherical high point, to be supplied and professionally installed, including cuts to fit the edge areas and using the edge board, Schlüter®-BEKOTEC-ENR 1520 P, if necessary, to be supplied and professionally installed while observing the manufacturer's instructions.

Material: _____/m²

Labour: _____/m²

Total price: _____/m²

_____ linear metres Schlüter®-BEKOTEC-BRS 810 as an edging strip made of closed cell polyethylene foam with an integrated foil leg, 8 mm thick and 100 mm high for installation at floor to wall transitions or fixed building elements, with the foil leg of the edging strip to be installed below the studded Schlüter®-BEKOTEC panel, to be supplied and professionally installed while observing the manufacturer's instructions.

Material: _____/m²

Labour: _____/m²

Total price: _____/m²

_____ linear metres of Schlüter®-BEKOTEC-BRSK 810 as an edging strip made of closed cell polyethylene foam with an integrated foil leg, 8 mm thick and 100 mm high for installation at floor to wall transitions or fixed building elements, to be adhered with the self adhesive strip on the reverse side, with the foil leg of the edging strip to be installed below the studded Schlüter®-BEKOTEC panel, to be supplied and professionally installed while observing the manufacturer's instructions.

Material: _____/m²

Labour: _____/m²

Total price: _____/m²

For flowing screeds:

_____ m² Schlüter®-BEKOTEC-EN 1520PF as a studded screed panel made of polystyrene EPS 033 DEO (PS 25) with a working area of 75.5 x 106 cm and a tongue and groove connection mechanism, with 70 studs of 24 mm height, of which 4 studs feature a 8 mm high hemispherical high point, to be supplied and professionally installed, including cuts to fit the edge areas and using the edge board Schlüter®-BEKOTEC-ENR 1520 P if necessary, while observing the manufacturer's instructions.

Material: _____/m²

Labour: _____/m²

Total price: _____/m²

_____ linear metres Schlüter®-BEKOTEC-BRS 808 KF as an edge insulation strip for flowing screeds, made of closed cell polyethylene foam, 8 mm thick and 80 mm high, with integrated self adhesive foam leg, to be installed at floor to wall transitions and fixed building elements and to be adhered with the adhesive strip on the back, with the adhesive leg of the edging strip to be installed below the studded screed panel and firmly adhered to the bottom of the studded panel, to be supplied and professionally installed while observing the manufacturer's instructions.

Material: _____/m²

Labour: _____/m²

Total price: _____/m²

_____ linear metres of Schlüter®-DILEX-DFP as an expansion joint profile of closed cell polyethylene foam, with lateral hard plastic coating, 10 mm thick, for installation in door transition areas with self adhesive base. The installation instructions of the manufacturer must be observed.

Height: ■ 60 mm ■ 80 mm ■ 100 mm

Material: _____/m²

Labour: _____/m²

Total price: _____/m²

_____ linear metres of oxygen proof heating pipes of synthetic material with ø _____ mm and a wall thickness of _____ mm, to be supplied and professionally installed between the studs of the studded polystyrene screed panel, Schlüter®-BEKOTEC-EN, in the required spaces, while observing the manufacturer's instructions.

Make: _____

Art.-No.: _____

Material: _____/m

Labour: _____/m

Total price: _____/m



_____ m²

- Cement screed of strength class CT-C25-F4 (ZE 20)
 - Conventional installation
 - Flowing screed
- Calcium sulfate screed of Strength class CA-C25-F4 (AE 20)
 - Conventional installation
 - Flowing screed

equivalent

to be installed with a minimum coverage of 8 mm above the studs of the Schlüter®-BEKOTEC-EN polystyrene panel without joints, to be compacted and smoothed, avoiding sound bridges at wall transitions or fixed building elements as well as doorsills, to be supplied and professionally installed while observing the manufacturer's instructions.

Material: _____/m²
 Labour: _____/m²
 Total price: _____/m²

_____m² Schlüter®-DITRA 25 as a tension neutralising and crack bridging uncoupling mat made of polyethylene, with cutback dovetail rib structure and anchoring fleece laminated on the underside, to be supplied and professionally installed on load bearing Schlüter®-BEKOTEC screed, using dry set thin-bed mortar.

- Install Schlüter®-DITRA 25 as an additional bonded waterproofing assembly. This requires the professional waterproofing of all connections at pipe sleeves, floor drains, wall fixtures and abutting joints with Schlüter®-KERDI-BAND. The resulting additional cost is to be
 - Included in the unit prices
 - Invoiced separately.

The installation instructions of the manufacturer must be observed.

Material: _____/m²
 Labour: _____/m²
 Total price: _____/m²

_____linear metres of Schlüter®-DILEX-BWB as a movement joint profile with lateral, trapezoid perforated anchoring legs of recycled rigid PVC and an approximately 10 mm flexible movement zone of soft CPE, to be supplied and professionally installed as part of the tile installation, while observing the manufacturer's instructions.

Colour: _____
 Profile height: _____
 Material: _____/m
 Labour: _____/m
 Total price: _____/m

_____linear metres of Schlüter®-DILEX-BWS as a movement joint profile with lateral trapezoid perforated anchoring legs of recycled rigid PVC and an approximately 5 mm flexible movement zone of soft CPE, to be supplied and professionally installed as part of the tile installation, while observing the manufacturer's instructions.

Colour: _____
 Profile height: _____
 Material: _____/m
 Labour: _____/m
 Total price: _____/m

_____linear metres of Schlüter®-DILEX-AKWS as a movement joint profile with laterally attached aluminium profiles with trapezoid perforated anchoring legs and a profile chamber for insertion of a 6 mm movement zone of synthetic material, to be supplied and professionally installed as part of the tile installation, while observing the manufacturer's instructions.

Profile height (depending on tile thickness): _____ mm
 Colour: _____
 Item no: _____
 Material: _____/m
 Labour: _____/m
 Total price: _____/m

_____linear metres of Schlüter®-DILEX-EK as a two part corner movement profile with a tongue and groove connection for permanently flexible joints at floor to wall transitions with trapezoid perforated rigid PVC anchoring legs and soft CPE expansion zone, suitable for absorbing vertical deformations up to 8 mm, to be supplied and professionally installed, while observing the manufacturer's instructions.

Colour: _____
 Profile height: _____
 Material: _____/m
 Labour: _____/m
 Total price: _____/m

_____ per metre Schlüter®-DILEX-RF as a two part corner profile with a tongue and groove connection for permanent flexible corner joints between floor and skirting or wall tiles, featuring trapezoid perforated anchoring legs made of rigid PVC and a movement zone made of soft CPE, suitable for accepting vertical movements up to approximately 8 mm, and install according to the manufacturer's specifications.

Profile height U: _____
 Profile height O: _____
 Colour: _____
 Art.-No.: _____
 Material: _____/m
 Labour: _____/m
 Total: _____/m

_____m²

- Tile
- Natural stone
- Artificial stone

of dimensionscm xcm
 Make: _____ Art.-No.: _____

to be supplied and professionally installed with the thin-bed method in dry set mortar over Schlüter®-DITRA 25, complete with grouting after the curing of the thin-bed mortar. The installation instructions of the manufacturers must be observed.

Material: _____/m²
 Labour: _____/m²
 Total price: _____/m²